

- ▶ High energy
- ▶ Up to 3 A pulse capability
- ▶ Instant voltage response
- ▶ No passivation effect

Type: TLP-96111/A

Performance Data

(Typical values for batteries stored at 25 °C for one year)

System	LTC and HLC
Nominal voltage	3.6 V
Nominal capacity	1.2 Ah
Nominal current	0.6 mA
Max. 1 s pulse to 3 V	3 A
Max. pulse length @ 0.5 A	1000 s
Delay time to 3 V @ 0.5 A	none
Weight	45 g
Temperature range	-40 °C ... +85 °C
Capacity retention after 10 yr	78 %

The battery is designed for applications where low background currents are combined with high current pulses. The **PulsesPlus** battery combines the inherent benefits of bobbin type Lithium Thionyl Chloride (LTC) batteries with a novel hermetically sealed Hybrid Layer Capacitor (HLC). The LTC battery contributes high energy density while the HLC contributes high pulse current capability. The overall self discharge is thus minimized while safety is maximized.

Voltage during a Pulse at +25 °C

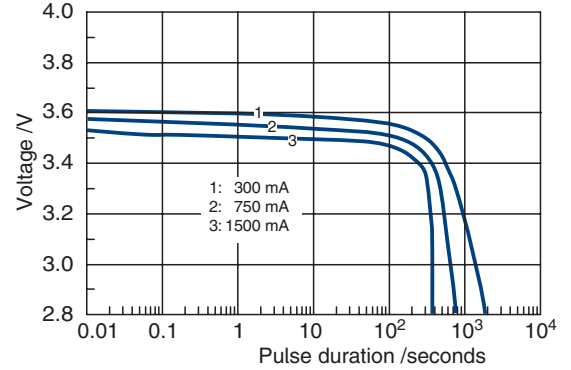

Maximum Pulse Width from 3.6 V to 2.8 V

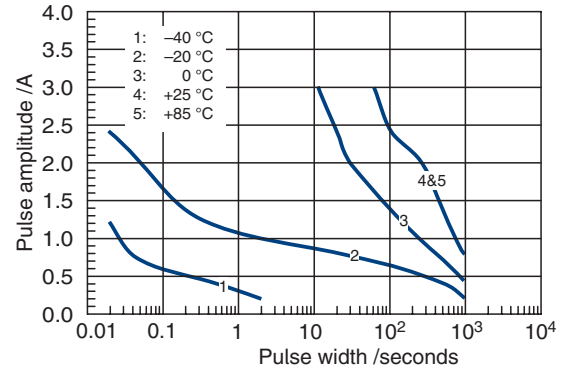

Pulse Voltage after 1 s

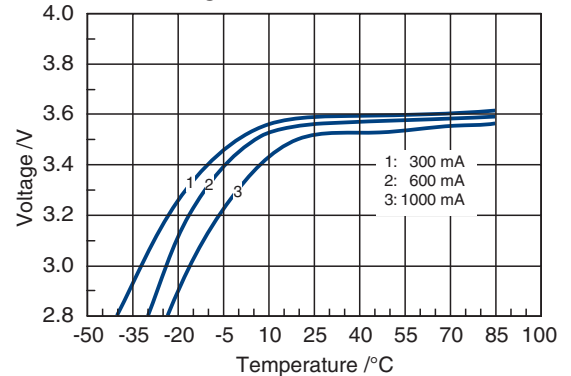

Available Capacity

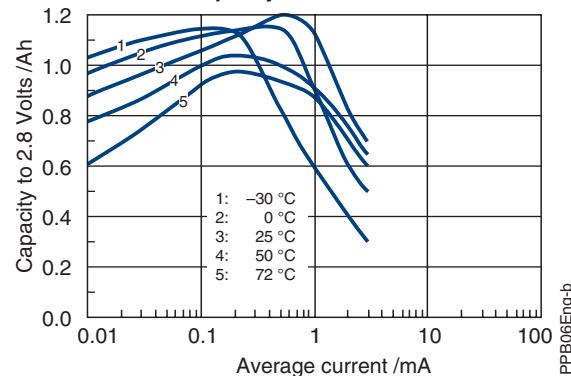

TLP-96111/A/SM

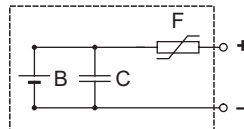
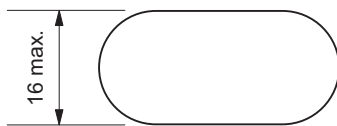
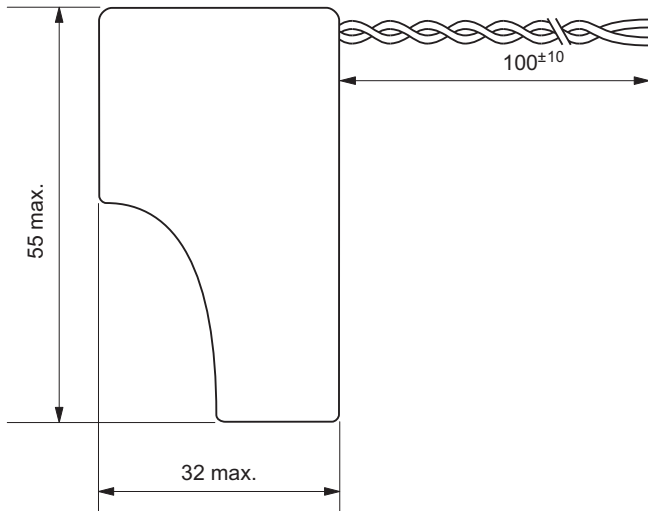

B = LTC battery
 C = HLC
 F = PTC (optional)

Both the LTC battery and the HLC are UL recognized.

Any values given here are for informational purpose only. They also depend on actual conditions of use and are not warranties of future performance. Subject to change.

Available Terminations

TLP-96111/A/SM Flying leads

Catalogue No.

14 1 5751 001